

HARDWARE

- SCREWS
- NUTS
- LAG BOLTS
- CARRIAGE BOLTS
- U-BOLTS
- BOLTS
- WASHERS
- PINS
- MISCELLANEOUS HARDWARE

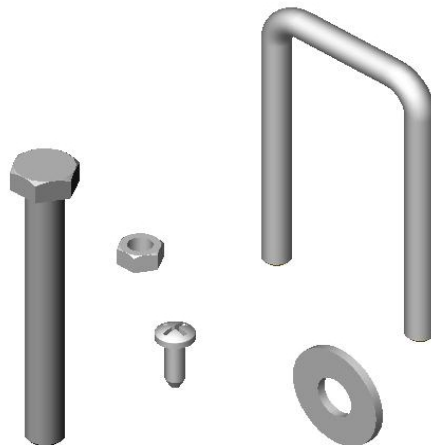

SCREWS

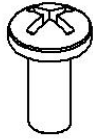
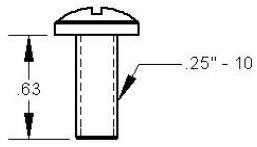

210-00268
SCREW, PHILLIPS
PAN HEAD, HI/LO
1/4" - 14 X 3/4"

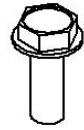
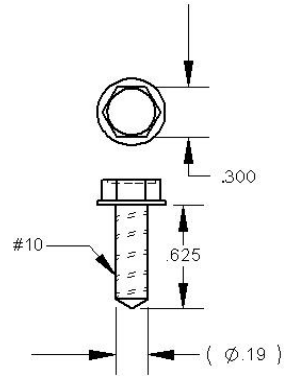

210-00057-NA
SCREW, #10 X 5/8
HEX WASHER HEAD

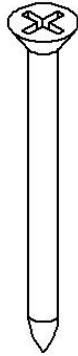
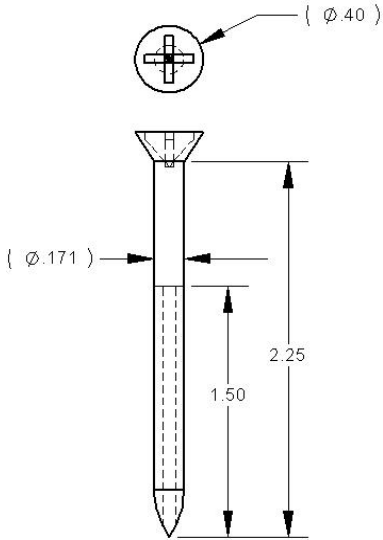

210-00007
SCREW, PHILLIPS
FLAT HEAD, WOOD
#12 X 2 1/2"

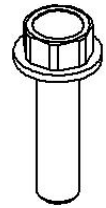
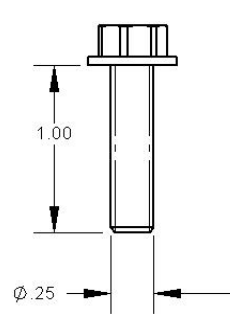

210-00121
SCREW W/WASHER
1/4" - 14 X 1
W/MILLED PNT

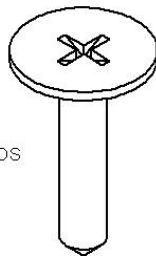
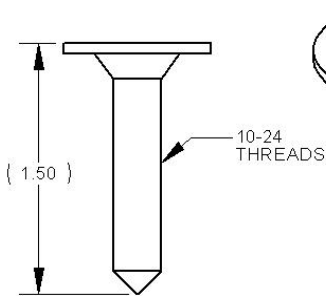

210-00083
SCREW, PHILLIPS
WATER TEK 3
#10-24 X 1 1/4"

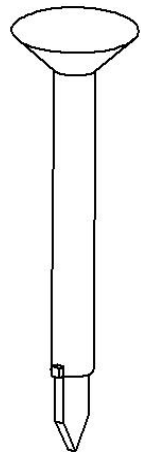
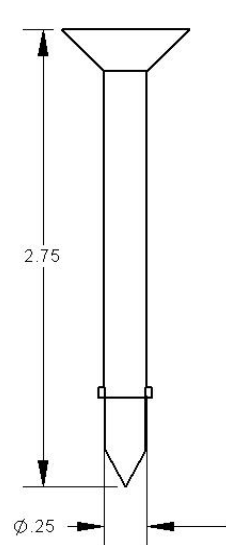

210-00131
SCREW, TORX
FLAT HEAD
SELF DRILL
14 X 2 3/4"

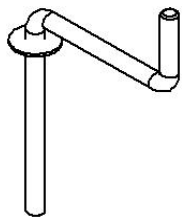

300-00191
TOM SCREW, BENT
SHORT
1/2" - 13

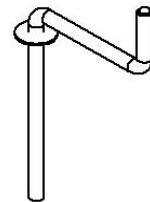

300-00194
TOM SCREW, BENT
LONG
1/2" - 13

NUTS

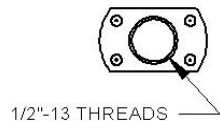

1/2"-13 THREADS



210-00001
NUT, WELDMENT
1/2" - 13

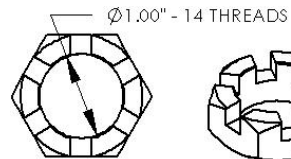

Ø1.00" - 14 THREADS

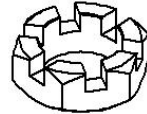

210-00062
NUT, SLOTTED JAM
(CASTLE NUT)
1" - 14

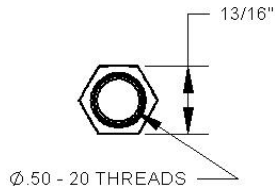

Ø.50 - 20 THREADS

13/16"



210-00137
LUG NUT
1/2" - 20 X 13/16"
210-00250
LUG NUT/ALUM RIM
1/2" - 20 X 13/16"

Ø5/16" - 18 THREADS

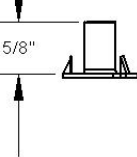
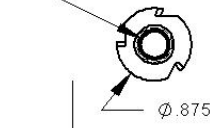

210-00173
NUT 5/16" - 18
T-NUT W/ 5/8"
BARREL LENGTH

Ø.165



210-00222
NUT
10-12 KEPS ZP



DIA " - THREADS

210-00004
NUT, REG HEX
5/16" - 18

210-00076
NUT, REG HEX
3/8" - 16

210-00092
NUT, REG HEX
1/4" - 20



210-00115
NUT, REG HEX
7/16" - 14

210-00085
NUT, CENTER
LOCK HEX NUT
1/4" - 20

210-00252
NUT, CENTER
LOCK HEX NUT
3/8" - 16



DIA " - THREADS

210-00043
NUT, NYLOCK
5/8" - 18

210-00046
NUT, NYLOCK
7/16" - 14

210-00047
NUT, NYLOCK
1/2" - 13

210-00048
NUT, NYLOCK
3/8" - 16



210-00071
NUT, NYLOCK
5/16" - 18

210-00157
NUT, NYLOCK
9/16" - 12

210-00201
NUT, NYLOCK
1/2" - 13

STAINLESS STEEL

LAG BOLTS

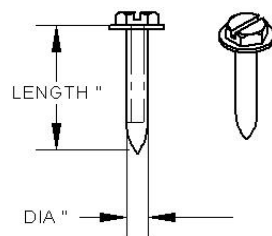

LENGTH "

DIA "

210-00273
LAG BOLT W/WASHER
1/2" DIA. X 1 1/2" LONG

210-00130
LAG BOLT
1/4" DIA. X 1 1/2" LONG

210-00229
LAG BOLT
1/4" DIA. X 1 3/4" LONG

CARRIAGE BOLTS

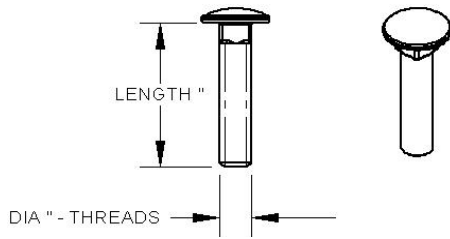

210-00258
CARRIAGE BOLT
1/4" - 20 X 3/4" L

210-00033
CARRIAGE BOLT
3/8" - 16 X 1 1/2" L

210-00145
CARRIAGE BOLT
1/4" - 20 X 2" L

210-00051
CARRIAGE BOLT
3/8" - 16 X 2 1/2" L

210-00003
CARRIAGE BOLT
5/16" - 18 X 2" L

210-00177
CARRIAGE BOLT
3/8" - 16 X 1 3/4" L

210-00132
CARRIAGE BOLT
3/8" - 16 X 7/8" L

210-00195
CARRIAGE BOLT
1/2" - 13 X 1 1/2" L

210-00194
CARRIAGE BOLT
3/8" - 16 X 7/8" L

210-00237
CARRIAGE BOLT
1/2" - 13 X 3" L

U-BOLTS

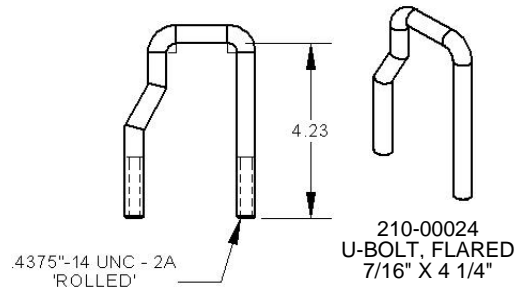
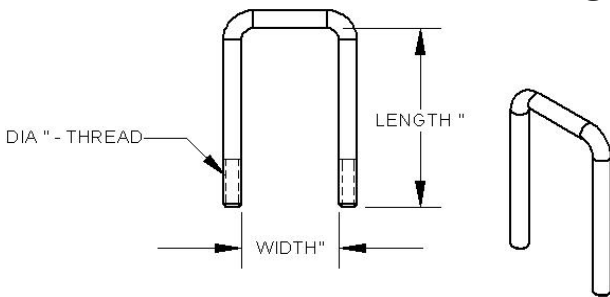

210-00065
U-BOLT
3/8" DIA. - 16
1 5/16" W X 2" L

3/8"

210-00184
U-BOLT
3/8" DIA. - 16
2 1/16" W X 2 7/8" L

210-00248
U-BOLT
3/8" DIA. - 16
1 9/16" W X 4" L

210-00054
U-BOLT
3/8" DIA. - 16
3 1/8" W X 2 3/8" L

210-00035
U-BOLT
3/8" DIA. - 16
1 7/8" W X 2" L

210-00074
U-BOLT
3/8" DIA. - 16
3 1/8" W X 4 1/8" L

210-00082
U-BOLT
3/8" DIA. - 16
1 7/8" W X 2 1/2" L

210-00059
U-BOLT
3/8" DIA. - 16
3 5/16" W X 2 3/8" L

210-00191
U-BOLT
3/8" DIA. - 16
1 9/16" W X 3 1/4" L

210-00231
U-BOLT
3/8" DIA. - 16
4 1/16" W X 3" L

210-00032
U-BOLT
3/8" DIA. - 16
2" W X 2" L

210-00210
U-BOLT
3/8" DIA. - 16
4 1/16" W X 4" L

210-00036
U-BOLT
3/8" DIA. - 16
2 1/32" W X 3 1/4" L

210-00248
U-BOLT
3/8" DIA. - 16
1 9/16" W X 4" L

210-00031
U-BOLT
3/8" DIA. - 16
2 1/32" W X 3 3/4" L

210-00224
U-BOLT
3/8" DIA. - 16
4 1/16" W X 5" L

210-00264
U-BOLT
3/8" DIA. - 16
2 1/8" W X 9 1/2" L

7/16"

210-00203
U-BOLT
7/16" DIA. - 14
1 5/16" W X 5 1/2" L

210-00193
U-BOLT
7/16" DIA. - 14
2.0975" W X 4" L

210-00034
U-BOLT
7/16" DIA. - 14
2.0975 X 4 1/2" L

210-00087
U-BOLT
7/16" DIA. - 14
2 1/4" W X 4" L

210-00068
U-BOLT
7/16" DIA. - 14
2 1/4" W X 5 5/16" L

210-00220
U-BOLT
7/16" DIA. - 14
2 1/4" W X 6 1/4" L

210-00053
U-BOLT
1/2" DIA. - 13
2 1/8" W X 4 1/4" L

210-00147
U-BOLT
1/2" DIA. - 13
2 1/8" W X 5 1/2" L

210-00126
U-BOLT
1/2" DIA. - 13
2 1/8" W X 6" L

210-00151
U-BOLT
1/2" DIA. - 13
3 1/16" W X 2 1/2" L

210-00028
U-BOLT
1/2" DIA. - 13
3 1/16" W X 3 1/2" L

210-00029
U-BOLT
1/2" DIA. - 13
3 1/16" W X 4 1/2" L

210-00030
U-BOLT
1/2" DIA. - 13
3 1/16" W X 5 1/4" L

210-00241
U-BOLT
1/2" DIA. - 13
3 1/16" W X 6 1/4" L

210-00182
U-BOLT
1/2" DIA. - 13
3 1/16" W X 6 3/4" L

210-00242
U-BOLT
1/2" DIA. - 13
3 1/16" W X 7 1/4" L

1/2"

210-00251
U-BOLT
1/2" DIA. - 13
3 1/16" W X 8" L

210-00212
U-BOLT
1/2" DIA. - 13
3 1/2" W X 3 1/2" L

210-00213
U-BOLT
1/2" DIA. - 13
3 1/2" W X 4" L

210-00214
U-BOLT
1/2" DIA. - 13
3 1/2" W X 8 1/4" L

210-00180
U-BOLT
1/2" DIA. - 13
3 9/16" W X 5 1/4" L

210-00181
U-BOLT
1/2" DIA. - 13
3 9/16" W X 6 1/4" L

210-00202
U-BOLT
1/2" DIA. - 13
3 1/16" W X 4 1/4" L
STAINLESS STEEL

210-00216
U-BOLT
1/2" DIA. - 13
4" W X 5 1/4" L

210-00215
U-BOLT
1/2" DIA. - 13
4" W X 6 1/4" L

210-00217
U-BOLT
1/2" DIA. - 13
6 1/2" W X 6" L

BOLTS

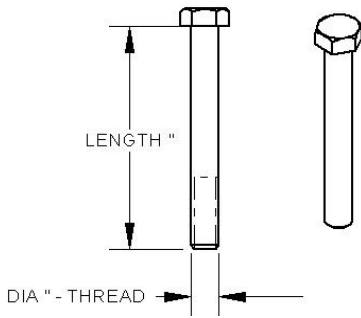

1/4"

210-00084
BOLT, HEX HEAD
1/4" - 20 X 3/4" L

210-00186
BOLT, HEX HEAD
1/4" - 20 X 2 3/4" L

5/16"

210-00097
BOLT, HEX HEAD
5/16" - 18 X 1" L

210-00174
BOLT, HEX HEAD
5/16" - 18 X 1 1/2" L

210-00027
BOLT, HEX HEAD
5/16" - 18 X 2" L

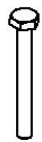
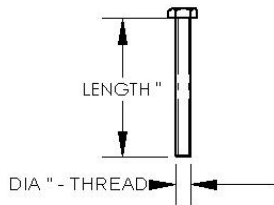

210-00122
BOLT, TAP
1/4" - 20 X 2 1/2" L

210-00123
BOLT, TAP
1/4" - 20 X 3 1/2" L

3/8"

210-00253
BOLT, HEX HEAD
3/8" - 16 X 7/8" L

210-00022
BOLT, HEX HEAD
3/8" - 16 X 1" L

210-00045
BOLT, HEX HEAD
3/8" - 16 X 1 1/2" L

210-00178
BOLT, HEX HEAD
3/8" - 16 X 1 3/4" L

210-00078
BOLT, HEX HEAD
3/8" - 16 X 2" L

210-00188
BOLT, HEX HEAD
3/8" - 16 X 2 1/4" L

210-00113
BOLT, HEX HEAD
3/8" - 16 X 2 1/2" L

210-00023
BOLT, HEX HEAD
3/8" - 16 X 2 3/4" L

210-00089
BOLT, HEX HEAD
3/8" - 16 X 3" L

210-00079
BOLT, HEX HEAD
3/8" - 16 X 3 1/2" L

210-00172
BOLT, HEX HEAD
3/8" - 16 X 3 3/4" L

210-00080
BOLT, HEX HEAD
3/8" - 16 X 4" L

210-00049
BOLT, HEX HEAD
3/8" - 16 X 4 1/2" L

210-00058
BOLT, HEX HEAD
3/8" - 16 X 5" L

210-00056
BOLT, HEX HEAD
3/8" - 16 X 6" L

210-00118
BOLT, HEX HEAD
3/8" - 16 X 6 1/2" L

210-00245
BOLT, HEX HEAD
3/8" - 24 X 1" L

7/16"

210-00006
BOLT, HEX HEAD
7/16" - 14 X 1" L

210-00208
BOLT, HEX HEAD
7/16" - 20 X 1" L

1/2"

210-00133
BOLT, HEX HEAD
1/2" - 13 X 1" L

210-00072
BOLT, HEX HEAD
1/2" - 13 X 1 1/4" L

210-00120
BOLT, HEX HEAD
1/2" - 13 X 1 1/2" L

210-00228
BOLT, HEX HEAD
1/2" - 13 X 2" L

210-00187
BOLT, HEX HEAD
1/2" - 13 X 2 1/2" L

210-00012
BOLT, HEX HEAD
1/2" - 13 X 3" L

210-00230
BOLT, HEX HEAD
1/2" - 13 X 3 1/4" L

210-00013
BOLT, HEX HEAD
1/2" - 13 X 3 1/2" L

210-00014
BOLT, HEX HEAD
1/2" - 13 X 4" L

210-00040
BOLT, HEX HEAD
1/2" - 13 X 4 1/2" L

210-00060
BOLT, HEX HEAD
1/2" - 13 X 5" L

210-00086
BOLT, HEX HEAD
1/2" - 13 X 5 1/2" L

210-00015
BOLT, HEX HEAD
1/2" - 13 X 6" L

210-00114
BOLT, HEX HEAD
1/2" - 13 X 6 1/2" L

210-00037
BOLT, HEX HEAD
1/2" - 13 X 7" L

210-00098
BOLT, HEX HEAD
1/2" - 13 X 8" L

210-00183
BOLT, HEX HEAD
1/2" - 13 X 9" L

210-00070
BOLT, HEX HEAD
1/2" - 13 X 10" L

1/2" STAINLESS

210-00200
BOLT, HEX HEAD
1/2" - 13 X 1 1/2" L
STAINLESS STEEL

210-00197
BOLT, HEX HEAD
1/2" - 13 X 1 3/4" L
STAINLESS STEEL

210-00198
BOLT, HEX HEAD
1/2" - 13 X 4" L
STAINLESS STEEL

210-00199
BOLT, HEX HEAD
1/2" - 13 X 4 1/2" L
STAINLESS STEEL

9/16"

210-00204
BOLT, HEX HEAD
9/16" - 12 X 3" L

210-00211
BOLT, HEX HEAD
9/16" - 12 X 3 1/4" L

210-00205
BOLT, HEX HEAD
9/16" - 12 X 4" L

5/8"

210-00041
BOLT, HEX HEAD
5/8" - 18 X 5" L

210-00221
BOLT, HEX HEAD
5/8" - 18 X 9" L

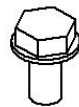
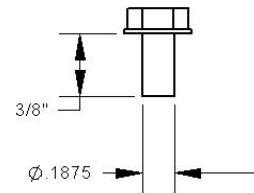

210-00223
BOLT, 10-24 X 3/8"

WASHERS

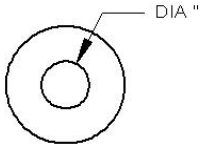

210-00219
WASHER, FLAT - 3/16"

210-00136
WASHER, FLAT - 1/4"

210-00025
WASHER, FLAT - 3/8"

210-00207
WASHER, FLAT - 3/8"
LARGE - 1 1/4" OD

210-00138
WASHER, FLAT - 7/16"

210-00017
WASHER, FLAT - 1/2"

210-00043
WASHER, FLAT - 1/2"
PLASTIC



210-00196
WASHER, FLAT - 1/2"
USS

210-00240
WASHER, FLAT - 1/2"
SAE

210-00019
WASHER, FLAT - 9/16"

210-00042
WASHER, FLAT - 5/8"

210-00038
WASHER, FLAT - 7/8"

210-00063
WASHER, FLAT - 1 3/4"

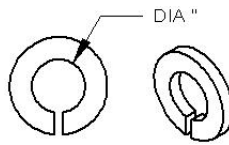

210-00117
WASHER, SPLIT LOCK
1/4" DIA.

210-00005
WASHER, SPLIT LOCK
5/16" DIA.

210-00077
WASHER, SPLIT LOCK
3/8" DIA.

210-00008
WASHER, SPLIT LOCK
7/16" DIA.



210-00225
WASHER, FLUSH KIT
.94 OD X .50 ID
.06 THICK



210-00139
WASHER, FLAT
1.46" OD X 1.13 ID
.128" THICK

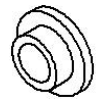

229-00229
WASHER,
NYLON SHOULDER

229-00329
WASHER,
3/8" X 3/4"
W/NYLON SHOULDER
BLACK



210-00149
WASHER
EXTERNAL
TOOTH 1/4"

PINS

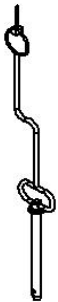

207-00009
1/2" X 6-1/2"
HITCH PIN



229-00114
SAFETY PIN
FOR LUBE SPINDLE
.15 X 1.5"



207-00007
CLEVIS PIN



100-01122-ZN
LOCKING PIN

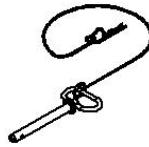

207-00002
5-1/2" TILT PIN
W/BRIDGE PIN

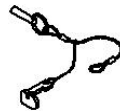

203-00058-SP2
HITCH PIN KIT
W/O RETAINING RING



207-00008
BRIDGE PIN

207-00016
BRIDGE PIN
7/8" - 1"



207-00014
RAMP PIN
W/KEEPER
(ULTRA)



207-00020
8" LANYARD & PIN



207-00003
RAMP PINS
5/16" (KS)

MISCELLANEOUS HARDWARE



229-00111
1/4" GREASE
FITTING



210-00243
RETAINING
RING 1" ID



210-00190
BALL STUD
RETAINING CLIP



210-00067
PAL NUT, 5/8"



210-00020
DRYWALL NAIL
1-1/2"



210-00206
RIVET
3/16 X 1/4 GRIP
BLIND RIVET
ALL ALUMINUM



210-00218
RIVET
3/16 X 1 GRIP
BLIND RIVET
ALL ALUMINUM



229-00289
KNOB ASSY
1/2" - 13
(Must order w/
bolt assy's)



229-00287
BOLT & KNOB ASSY
1/2" - 13 X 5.25"
(Sold only as a set
- must order
p/n 229-00289 & 229-00287)



210-00073
THREADED
INSERT
1/2" - 13



210-00081
THREADED
INSERT
SETTING TOOL



210-00185
7/8" EYE BOLT
WITH 1-1/4"
EYE



207-00017
12" LANYARD
W/2 LOOPS

229-00288
BOLT & KNOB ASSY
1/2" - 13 X 6.25"
(Sold only as a set
- must order
p/n 229-00289 & 229-00288)